



## WARNING

Before using our products, please read this manual carefully to understand the proper use of your unit.

## Operator's manual

# 170BT

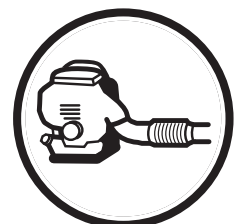

**English**

APPLICABLE SERIAL NUMBERS: 60200101 and up

## EC-declaration of conformity

### EC-declaration of conformity

#### (Applies to Europe only)

Husqvarna AB, SE-561 82 Huskvarna, Sweden, tel +46-36-146500, declares under sole responsibility that the blowers Husqvarna 170BT with serial numbers dating 2006 and onwards (the year is clearly stated on the rating plate, followed by the serial number), comply with the requirements of the COUNCIL'S DIRECTIVE:

of June 22, 1998 "relating to machinery" **98/37/EC**, annex IIA.

of May 3, 1989 "relating to electromagnetic compatibility" **89/336/EEC**, and applicable supplements.

of May 8, 2000 "relating to the noise emissions in the environment" **2000/14/EC**.

For information relating to noise emissions, see the chapter Technical data. The following standards have been applied: **ISO 7917:1987**, **CISPR 12:2005**, **ISO 14740:1998**.

TUV Rheinland Japan Ltd., 9F 3-19-5 Shin Yokohama, Kohoku-ku, Yokohama 222-0033, Japan, has performed voluntary type examination on behalf of Husqvarna AB. The certificates are numbered: AM5007/9255/0001

Huskvarna 10/03/2006



Bo Andréasson, Managing director

APPROVAL NUMBER OF CE EXHAUST EMISSION REGULATION (2002/88/EC)  
e13\*97/68SH3G3\*2002/88\*0223\*00

# Contents

<b>Safety</b> .....	<b>4</b>
SAFETY FIRST .....	4
Notes on types of warnings .....	4
<b>Warning labels on the machine</b> .....	<b>4</b>
Symbols .....	4
<b>Symbols on the machine</b> .....	<b>5</b>
<b>Safety Precautions</b> .....	<b>5</b>
WORKING CONDITIONS .....	6
WORKING CIRCUMSTANCE .....	6
AVOID NOISE PROBLEM .....	6
WORKING PLAN .....	6
FUEL .....	6
BEFORE STARTING THE ENGINE .....	6
USING THE PRODUCT .....	7
MAINTENANCE .....	7
TRANSPORTATION .....	7
STORAGE .....	7
<b>What is what?</b> .....	<b>8</b>
<b>Technical data</b> .....	<b>9</b>
<b>Assembly</b> .....	<b>10</b>
SWIVEL JOINT .....	10
THROTTLE LEVER .....	10
THROTTLE CABLE .....	10
HANDLEBAR [OPTION] .....	10
BLOWER TUBES .....	10
HARNES .....	11
WAIST BELT .....	11
<b>Fuel</b> .....	<b>12</b>
FUEL .....	12
HOW TO MIX FUEL .....	12
FUELING THE UNIT .....	12
<b>Operation</b> .....	<b>13</b>
STARTING ENGINE .....	13
ADJUSTING IDLE SPEED .....	13
STOPPING ENGINE .....	13
<b>Maintenance</b> .....	<b>14</b>
AIR CLEANER .....	14
FUEL FILTER .....	14
SPARK PLUG .....	15
MUFFLER .....	15
SPARK ARRESTER .....	15
AIR INLET NET .....	15
IGNITION COIL AIR GAP INSPECTION .....	16
SHOLDER STRAP .....	16
<b>Storage</b> .....	<b>16</b>

# Safety



## SAFETY FIRST

Instructions contained in warnings within this manual and warning seals marked with a  symbol on the blower concern critical points which must be taken into consideration to prevent possible serious bodily injury, and for this reason you are requested to read all such instructions carefully and follow them without fail.

## Notes on types of warnings

### WARNING

Instructions labeled as shown above, concern critical steps or procedures which must be followed in order to prevent accidents which could lead to serious bodily injury or death. This mark is used to indicate instructions which must be followed without exception.

### IMPORTANT

Instructions labeled as shown above concern steps or procedures which, if not followed correctly, could lead to mechanical failure, breakdown, or damage.

### NOTE

Used to label supplementary instructions designed to provide hints or directions useful in the use of the product.

## Warning labels on the machine

### Symbols

WARNING! The machine can be a dangerous tool if used incorrectly or carelessly, which can cause serious or fatal injury to the operator or others.



Please read the operator's manual carefully and make sure you understand the instructions before using the machine.

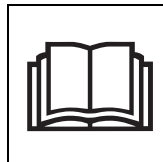

Always wear:

- Hearing protection
- Approved eye protection



This product is in accordance with applicable EC directives.



Always wear protective gloves.



The blower can forcibly throw objects that can bounce back. This can result in serious eye injuries if the recommended safety equipment is not used.



The blower operator must make sure that no bystanders or animals come nearer than 50 feet (15 meters). Whenever several operators are working in the same work area, they should maintain a safe distance of at least 50 feet (15 meters) from one another.



A breathing mask should be used when there is a risk of dust.



Keep all parts of your body away from hot surfaces.



Other symbols/decals on the machine refer to special certification requirements for certain markets.

### IMPORTANT

If the warning label peels off or becomes soiled and impossible to read, you should contact the dealer from which you purchased the product to order new labels and affix them in the required location(s).

## Symbols on the machine



For safe operation and maintenance, symbols are carved in relief on the machine. Using to these indications, please be careful not to make a mistake.

- (a) The port to refuel the "MIX GASOLINE"  
**Position:** FUEL TANK CAP
- (b) The direction to close the choke  
**Position:** INTAKE CUP
- (c) The direction to open the choke  
**Position:** INTAKE CUP
- (d) The direction to stop the engine  
**Position:** THROTTLE LEVER

## Safety Precautions

### ⚠ WARNING

1. Read this Blower Operator Manual carefully. Be sure you understand how to operate this unit properly before you use it. Failure to do so could result in serious injury.
2. Be sure to keep this manual handy so that you may refer to it later whenever any questions arise. Also note that you are requested to contact the dealer from whom you purchased the product for assistance the event that you have any questions which cannot be answered herein.
3. Always be sure to include this manual when selling, lending, or otherwise transferring the ownership of this product.
4. Do not lend or rent your machine without the owner's manual.
5. Be sure that anyone using your unit understands the information contained in this manual.
6. Never let a child use the machine.
7. Long-term exposure to noise can result in permanent hearing impairment. So always use approved hearing protection.

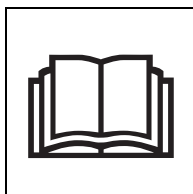

8. Under no circumstances may the design of the machine be modified without the permission of the manufacturer. Always use genuine accessories. Non-authorized modifications and/or accessories can result in serious personal injury or the death of the operator or others.
9. A blower is a dangerous tool if used carelessly or incorrectly and can cause serious, even fatal injuries. It is extremely important that you read and understand the contents of this Operator's manual.
10. Husqvarna AB has a policy of continuous product development and therefore reserves the right to modify the design and appearance of products without prior notice.
11. The machine is only designed for blowing lawns, pathways, asphalt roads and the like.

# Safety Precautions

## WORKING CONDITIONS

1. Refrain from operating the blower if you are tired, ill, or upset, or if you are under the influence of alcohol, drugs or medication
2. To reduce the risk of hearing loss associated with sound levels, hearing protection is required.
3. To reduce the risk of injury associated with thrown objects, always wear eye protection and foot protection. Approved protective goggles must comply with standard ANSI Z87.1 in the USA or EN 166 in EU countries.



4. To reduce the risk of injury associated with the inhalation of dust, use a face filter mask in dusty conditions.
5. Wear rubber-soled shoes or shoes with some other form of anti-slip protection to help protect you against falling.



6. To reduce the risk of injury associated with objects being drawn into rotating parts, do not wear loose clothing, scarves, neck chains, unconfined long hair, or other loose material.



7. Prolonged use of a blower, exposing the operator to vibrations and cold, may produce whitefinger disease (Raynaud's phenomenon), the symptoms of which include tingling and burning sensations followed by loss of color and numbness in the fingers. All factors which contribute to whitefinger disease are not known, but cold weather, smoking diseases or physical conditions as well as long periods of exposure to vibration are mentioned as factors. In order to reduce the risk of whitefinger disease, the following precautions are strongly recommended

- a) Keep your body warm. Never use the blower during rain.
- b) Wear thick anti-vibration gloves.
- c) Take more than 5 minutes of break in a warm place frequently.
- d) Maintain a firm grip at all times, but do not squeeze the handles with constant, excessive pressure.
- e) If you feel discomfort, redness and swelling of your fingers or any other part of your body, see a doctor before it gets worse.



8. The ignition system of your unit produces an electromagnetic field of a very low intensity. This field may interfere with some pacemakers. To reduce the risk of serious or fatal injury, people with pacemaker should consult their physician and the pacemaker manufacturer before operating this tool.

## WORKING CIRCUMSTANCE

1. To reduce the risk of injury associated with exhaust fume inhalation, do not operate in unventilated area. The exhaust gases contain harmful carbon monoxide.
2. Avoid using the blower where stable footing and balance are not assured.
3. Never operate the machine in high wind, bad weather, when visibility is poor or in very high or low temperatures. (Our recommended use environment is below 40 degrees C (104 degrees F).)



## AVOID NOISE PROBLEM

### NOTE

Check and follow the local regulations as to sound levels and hours of operations for blower.

1. Operate power equipment only at reasonable hours, not early in the morning or late at night when people might be disturbed. Comply with times listed in local ordinances.
2. To reduce sound levels, limit the number of pieces of equipment used at any one time.
3. Operate power blowers at the lowest possible throttle speed to do the job.
4. Check your equipment before operation, especially the muffler, air intakes and air filters.

## WORKING PLAN

- When planning your work schedule, allow plenty of time to rest. Limit the amount of time over which the product is to be used continuously to somewhere around 30 to 40 minutes per session, and take 10 to 20 minutes of rest between work sessions. Also try to keep the total amount of work performed in a single day under 2 hours or less.

## FUEL

### WARNING

To reduce the risk of fire and burn injury:

- a) Handle fuel with care. It is highly flammable.
- b) Do not smoke while handling fuel.
- c) Do not refuel a hot engine.
- d) Do not refuel a running engine.
- e) Avoid spilling fuel or oil. Always wipe unit dry before using.
- f) Move at least 10 ft. (3 meters) away from the fueling point before starting the engine.
- g) Always store gasoline in a container approved for flammable liquids.
- h) Make sure the unit is properly assembled and in good operating condition.
- i) Do not use the blower near a fire, as aiming the blower in the direction of a flame may cause flammable substances to ignite.



## BEFORE STARTING THE ENGINE

- Each time before starting the engine, inspect the entire unit to see if every part is in good order and is securely tightened in place. If any damage is found in the fuel line, the exhaust line, or the ignition wiring, do not use the blower until it has been repaired.

### IMPORTANT

Before starting operation, always make sure to check if any obstacles are left inside the volute case and net. The obstacles may cause serious injury or damage to fan and volute case.

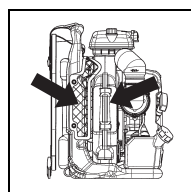

# Safety Precautions

## ⚠ WARNING

Check to see if the shock-absorbing rubber mount has become cracked or otherwise damaged. Note that failing to replace this rubber mount when it has become cracked or damaged may cause the engine to come loose from its frame during use, thus resulting in possible serious bodily injury.

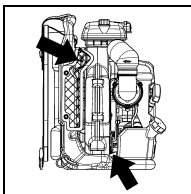

If cracked, be sure to replace without delay.

## ⚠ WARNING

To reduce the risk of injury associated with contacting rotating parts, stop the engine before installing or removing attachments. **Do not operate without net in place.** Always disconnect the spark plug before performing maintenance or accessing movable parts.

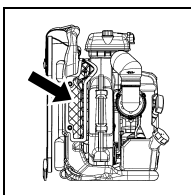

## USING THE PRODUCT

### ⚠ WARNING

While using the product, if abnormal noise or vibration occurs, stop the engine immediately and contact the nearest Husqvarna servicing dealer for assistance. Checking the fan is very important. If the rotating fan should break up, it will lead to serious accidents.

- Check the work area that the blower will be used in and remove or cover all valuables that may be damaged by the air blast or thrown debris.
- To reduce the risk of injury associated with thrown objects.
  - Watch out for children, pets, open windows or freshly washed cars, and blow debris safely away.
  - Use the full blower tube extension so the air stream can work close to the ground.
  - Do not allow bystanders in work area.
  - Do not point the blower tube in the direction of people or pets.
  - Always check to be sure that no debris has been blown onto someone else's property.
  - Pay attention to the direction of the wind, do not work against the wind.
- To minimize blowing time.
  - Use rakes and brooms to loosen debris before blowing.
  - In dusty conditions, slightly dampen surfaces or use a mister attachment when water is available.
  - Conserve water by using power blowers instead of hoses for many lawn and garden applications, including areas such as gutters, screens, patios, grills, porches and gardens.
- The blower must not be used while on a ladder or scaffolding.

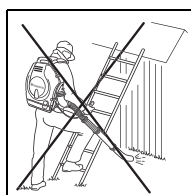
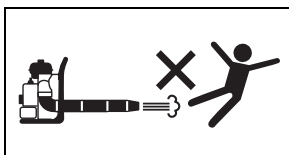

- Never put the machine down with the engine running unless you have it in clear sight.

- Never touch the spark plug or plug cord while the engine is in operation. Doing so may result in being subjected to an electrical shock.

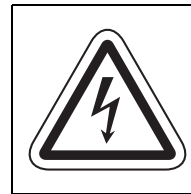

- Never touch the muffler, spark plug, or other metallic parts of the engine, or area around the engine cover while the engine is in operation or immediately after shutting down the engine. These metallic parts reach high temperatures during operation and doing so could result in serious burns.

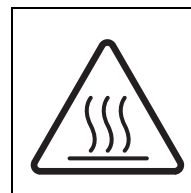

### ⚠ WARNING

The temperature of the machine may increase after stopping the engine. Especially never forget to cool down the engine before refueling the machine.

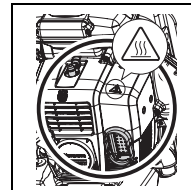

- After using blowers and other equipment, CLEAN UP! Dispose of debris in trash receptacles.

## MAINTENANCE

- In order to maintain your product in proper working order, perform the maintenance and checking operations described in the manual at regular intervals.
- Always be sure to turn off the engine and disconnect the spark plug before performing any maintenance or checking procedures.

### ⚠ WARNING

The metallic parts, engine cover, and area around the engine reach high temperatures immediately after stopping the engine.

- Examine the blower at intervals for loose fasteners and rusted or damaged parts. Use special care **around the fuel line, the muffler, and the ignition wiring.**
- All engine service except for those described in this manual should be performed by competent service personnel. Improper service to the blower fan and muffler could cause a hazardous failure.
- When replacing the any other part or any lubricant, always be sure to use only Husqvarna products or products which have been certified by Husqvarna for use with the Husqvarna product.
- In the event that any part must be replaced or any maintenance or repair work not described in this manual must be performed, please contact the nearest Husqvarna servicing dealer for assistance.
- Do not use any accessory or attachment other than those bearing the Husqvarna mark and recommended for the unit.
- Under no circumstances should you ever take apart the product or alter it in any way. Doing so might result in the product becoming damaged during operation or the product becoming unable to operate properly.

## TRANSPORTATION

- Drain the fuel from the fuel tank before transporting or storing the blower.
- Secure the blower so that it does not receive damage from shock doing transportation.
- Do not apply strong forces to the blower, such as throwing it or dropping it. Doing so invalidates the warranty.

## STORAGE

- When storing the blower, choose a space indoors free from moisture and out of the reach of children.

## What is what?

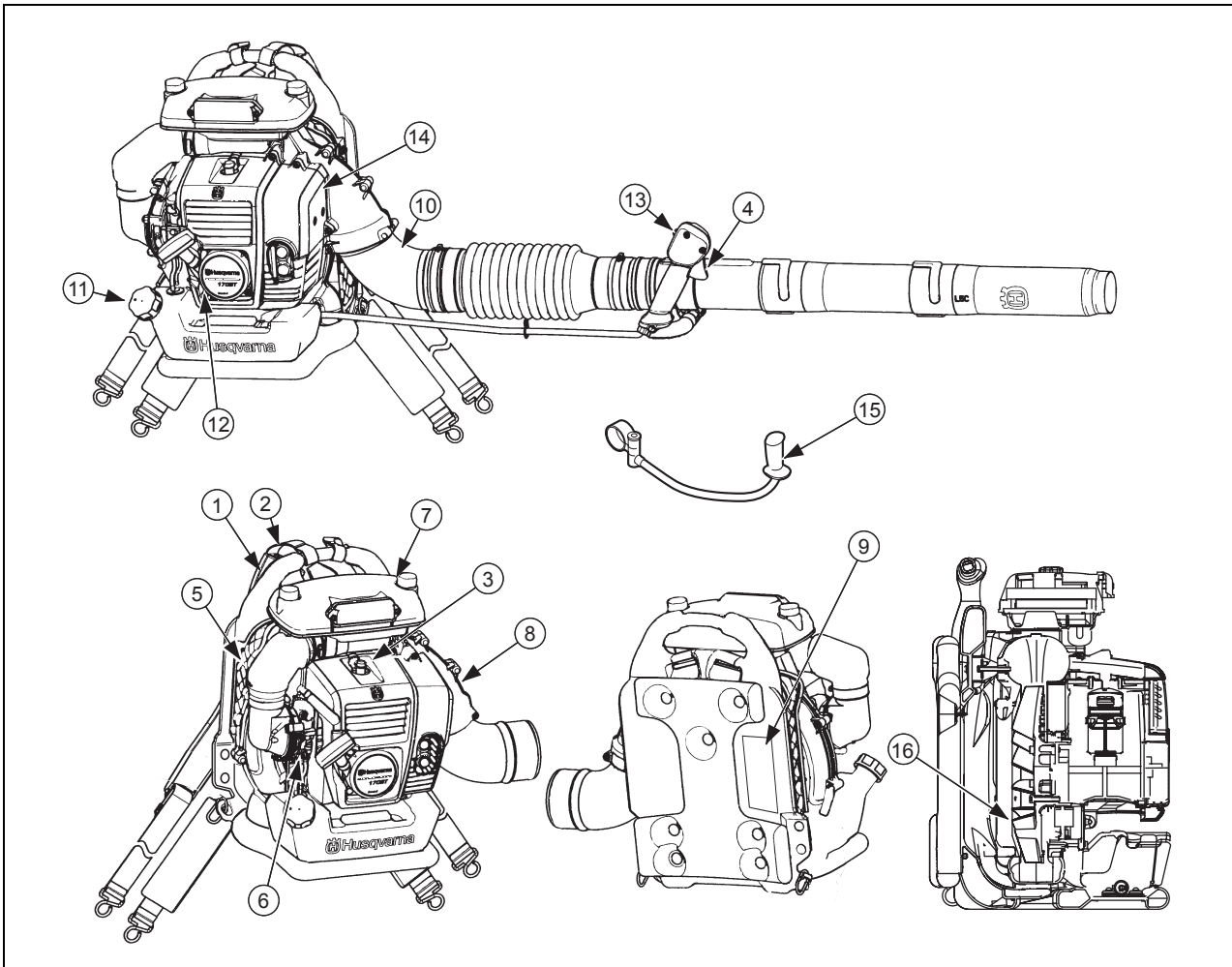

- |                   |                            |
|-------------------|----------------------------|
| 1. Frame          | 9. "CAUTION" Label         |
| 2. Shoulder Strap | 10. Elbow                  |
| 3. Spark Plug Cap | 11. Fuel Tank              |
| 4. Throttle Lever | 12. Recoil Starter         |
| 5. Net            | 13. Ignition Switch        |
| 6. Choke Lever    | 14. Engine Cover           |
| 7. Air Cleaner    | 15. Handle Bar (Accessory) |
| 8. Volute Case    | 16. Fan                    |

### ■ DISPOSAL

When disposing your machine, fuel or oil for the machine, be sure to allow your local regulations.

Frame:	PE (Polyethylene)
Shoulder strap:	Chemical fiber
Throttle lever:	Metal, Plastic
Volute case, Volute cover, Engine cover:	PA66GF (Glass-reinforced nylon), Brass
Pad:	Chemical fiber
Hose:	EVA (Ethylene vinyl acetate)
Pipes:	PP (Polypropylene)
Fan:	PA66GF (Glass-reinforced nylon)
Element:	Paper, Urethane

\* The insert nut of volute case, volute cover and fan can be taken off.



## Technical data

MODEL	170BT
Dimensions (L x W x H) mm (in)	365x464x485 (14x18x19)
Dry Weight kg (lbs) (including pipe)	12 (26.5) (total weight)
Fuel Tank Capacity liter (fl. oz)	1.75 (60.0)
Engine Type	Air cooled 2-cycle gasoline engine
Piston Displacement cu. cm (cu. in)	64.9 (4.0)
Air Filter	2-stage fresh flow filter system
Carburetor (Diaphragm) valve type	Rotary
Ignition System	Digital Ignition
Spark Plug	NGK CMR7H (Noise-proof)
Muffler	Spark arrester equipped
Idle speed rpm	2000
Operating Engine Speed rpm	2000 to 6900
Fuel Consumption liter/h (fl. oz/h)	1.6 (54.1)
Average Air Volume (w/std Pipe) cu. m/min (cf/m)	16 (565)
Max. Air Velocity m/sec (mph) (Average)	78 (175)
Durability Period hrs.	300
Noise Level (50 Feet ANSI B175. 2002) dB(A)	76
Sound power level EC directive 2000/14/EC, measured dB (A)	110
Sound power level EC directive 2000/14/EC, guaranteed dB (A)	110
Noise pressure level at the operator's ear EN/ISO11806 and ISO7917 dB (A)	95
Vibration level at idle, right handle EN/ISO11806 and ISO7916 m/s <sup>2</sup>	0.8
Vibration level at max, speed, right handle EN/ISO11806 and ISO7916 m/s <sup>2</sup>	3.9

\* The data shown above are those in the case of one straight pipe.

\* Specifications are subject to change without notice.

# Assembly

## ■ SWIVEL JOINT

1. Connect the blower and swivel joint with flexible hose. Clamp both ends of the flexible hose securely with the hardware supplied with the unit.

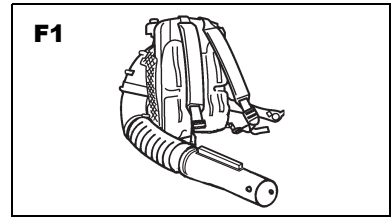

## ■ THROTTLE LEVER

1. Set up the throttle holder to the swivel and tighten the screw on the holder.

When setting up the holder, please make sure to match the holder to the convex on the swivel joint as shown in F2.

2. Adjust the position and angle to achieve a comfortable working position, and tighten the throttle lever.

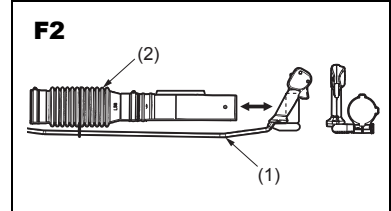

- (1) Cable
- (2) Hose

## ■ THROTTLE CABLE

- Use the clamp to fasten the colgate tube containing the throttle cable and the power cable to the hose.

- (1) Clamp

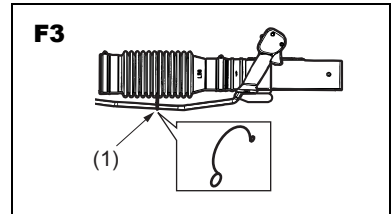

## ■ HANDLEBAR [OPTION]

1. Insert the holder, then assemble the handlebar (OPTION) and tighten it securely.

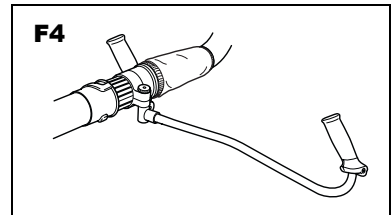

## ■ BLOWER TUBES

1. Align the protrusion and the groove provided on the tube ends and twist the tube until the connection is locked.

### NOTE

A light lubricant may be used to ease assembly of flexible pipe to blower elbow.

### NOTE

If longer tube is required, the second straight pipe can be connected with the first one.

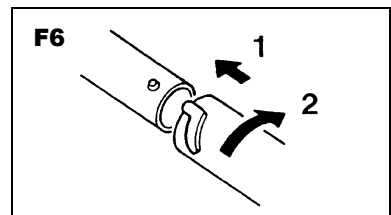
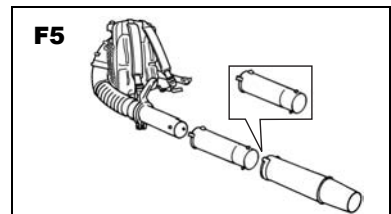

# Assembly

## ■ HARNESS

### NOTE

The harness must always be worn when working with the machine. Failure to do so means you will be unable to maneuver safely and this can result in injury to yourself or others.

A correctly adjusted harness and machine significantly facilitates the work. Adjust the harness to give the best working position.

Tighten the side straps so that the pressure is evenly distributed across the shoulders.

## ■ WAIST BELT

- The waist belt is attached to the rings on the left and right sides of the frame.

Place the waist belt over your waist and not too far down on the stomach. Tighten the waist belt strap so that you feel the weight of the blower resting on your hip.

- Be sure to always tighten the buckle in front of your body.

### WARNING

- If you are not using a waist belt, be sure to remove it from the unit and store it.
- There is a risk that the belt will be caught, toppling the unit.
- There is a danger that the belt will be sucked into the fan.

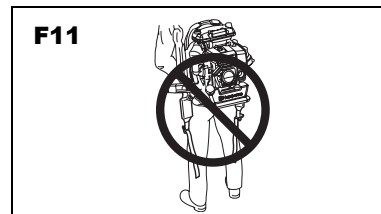
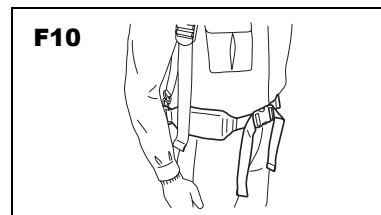
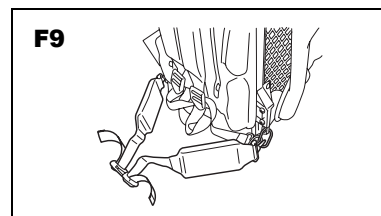
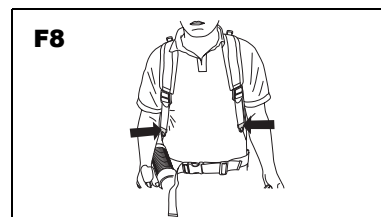
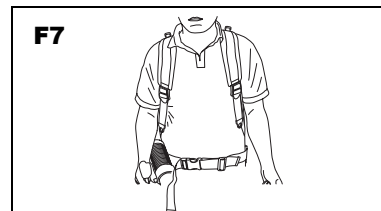

# Fuel

## FUEL

### ⚠ WARNING

- Gasoline is very flammable. Avoid smoking or bringing any flame or sparks near fuel. Make sure to stop the engine and allow it cool before refueling the unit. Select outdoor bare ground for fueling and move at least 10ft (3m) away from the fueling point before starting the engine.
- The engines are lubricated by oil specially formulated for air-cooled 2-cycle gasoline engine use. If Husqvarna oil is not available, use an anti-oxidant added quality oil expressly labeled for air-cooled 2-cycle engine use. (JASO FC GRADE OIL or ISO EGC GRADE)
- Do not use BIA or TCW (2-stroke water-cooling type) mixed oil.

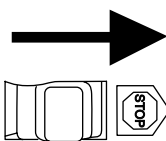

### RECOMMENDED MIXING RATIO GASOLINE 50:OIL 1

- Exhaust emission are controlled by the fundamental engine parameters and components (i.e., carburation, ignition timing and port timing) without addition of any major hardware or the introduction of an inert material during combustion.
- These engines are certified to operate on unleaded gasoline.
- Make sure to use gasoline with a minimum octane number of 89 RON (USA/Canada: 87AL)
- If you use a gasoline of a lower octane value than specified, there is a danger that the engine temperature may rise and an engine problem such as piston seizing may consequently occur.
- Unleaded gasoline is recommended to reduce the contamination of the air for the sake of your health and the environment.
- Poor quality gasolines or oils may damage sealing rings, fuel lines or fuel tank of the engine.

## HOW TO MIX FUEL

### ⓘ IMPORTANT

Pay attention to agitation.

- Measure out the quantities of gasoline and oil to be mixed.
- Put some of the gasoline into a clean, approved fuel container.
- Pour in all of the oil and agitate well.
- Pour in the rest of gasoline and agitate again for at least one minute. As some oils may be difficult to agitate depending on oil ingredients, sufficient agitation is necessary for the engine to last long. Note that, if the agitation is insufficient, there is an increased danger of early piston seizing due to an abnormally lean mixture.
- Indicate the contents on outside of container for easy identification to avoid mixing with raw gasoline or other containers.

## FUELING THE UNIT

- Untwist and remove the fuel cap.
- Put fuel into the fuel tank to 80% of the full capacity.
- Fasten the fuel cap securely and wipe up any fuel spillage around the unit.

### ⚠ WARNING

- Select bare ground for fueling.
- Move at least 10 feet (3 meters) away from the fueling point before starting the engine.
- Stop the engine and let it cool for a few minutes before refueling the unit. At that time, be sure to sufficiently agitate the mixed gasoline in the container.
- Do not smoke or place hot objects near fuel.

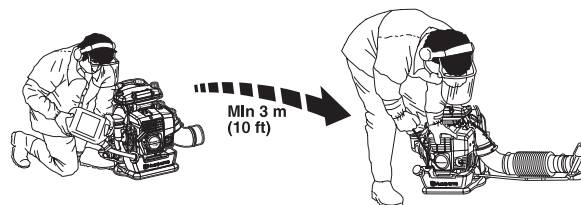

### FOR YOUR ENGINE LIFE, AVOID;

- FUEL WITH NO OIL (RAW GASOLINE) - It will cause severe damage to the internal engine parts very quickly.
- GASOHOL - It can cause deterioration of rubber and/or plastic parts and disruption of engine lubrication.
- OIL FOR 4-CYCLE ENGINE USE - It can cause spark plug fouling, exhaust port blocking, or piston ring sticking.
- Mixed fuels which have been left unused for a period of one month or more may clog the carburetor and result in the engine failing to operate properly.
- When storing the product for a long period of time, clean the fuel tank after rendering it empty. Next, activate the engine and empty the carburetor of the composite fuel.
- When scrapping the used mixed oil container, scrap it only at an authorized repository site.

### 📖 NOTE

For details of quality assurance, read the description in the Warranty section carefully. Moreover, normal wear and change in product with no functional influence are not covered by the warranty. Also, note that if the usage in the instruction manual is not observed for the mixed gasoline, etc. as described herein, it may not be covered by the warranty.

# Operation

## ■ STARTING ENGINE

### ! IMPORTANT

- Avoid operating the blower with the flexible tube and swivel joint disconnected. That will reduce the cooling air and the engine could be damaged by overheating.

1. Push the primer bulb until fuel flows out in the clear tube. (F12)
2. When the engine is cool, close the choke. (F12)

- (1) Choke Lever  
 (2) Primer Bulb  
 (3) OPEN  
 (4) CLOSE

3. Set the throttle lever in about 1/3 open position. (F13)

- (1) Full Throttle  
 (2) About 1/3 Open  
 (3) Idling  
 (4) STOP  
 (5) Stop Switch

4. To start, hold the top of the blower firmly with your left hand. Pull the starter knob slowly until you feel it engage and then give it a vigorous strong pull. (F14)

### ! IMPORTANT

- Never twist the starter cord around your hand.
- Avoid pulling the starter rope out to its full extent and allowing the starter rope to snap back. This will prevent premature damage to the starter.
- Do not let a person stand near the blower or the exhaust port.

5. Once the engine is running, gradually open the choke if it was set closed, and let the engine run at idle speed for a minute to warm it up.

### NOTE

When the engine fails to start after several attempts due to overchoking, open the choke and repeat pulling the rope.

## ■ ADJUSTING IDLE SPEED

- The idling speed is set for 2000 rpm at the factory. If it is necessary to adjust the idle speed, use the adjustment screw on the top side of carburetor.

- (1) Idling Adjustment Screw

## ■ STOPPING ENGINE

- Move the throttle lever to the STOP position.

- (4) Stop

### NOTE

If the engine does not stop when setting the ignition switch to the stop position, close the choke lever and stop the engine. In this case, please repair the machine at your nearest servicing dealer.

- (1) Choke Lever  
 (2) OPEN  
 (3) CLOSE

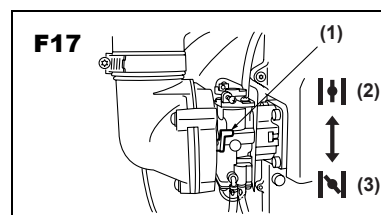
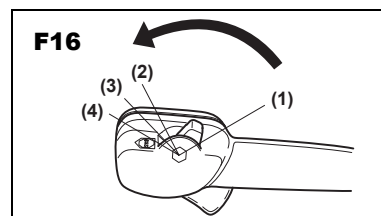
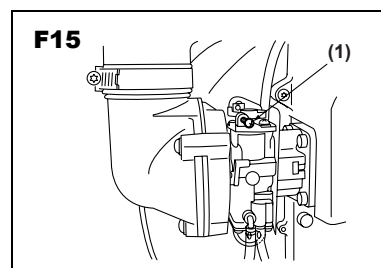
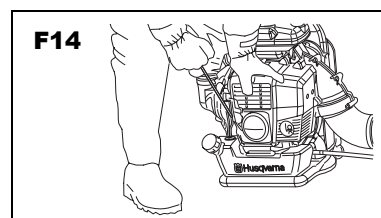
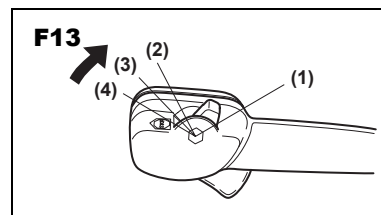
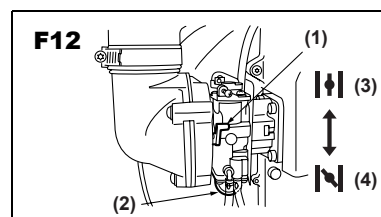

# Maintenance

Maintenance, replacement, or repair of the emission control device and systems may be performed by any non-road engine repair establishment or individual.

System/Component		Procedure	Daily or Before use	Every 25 hours after	Every 50 hours after	Every 100 hours after
Air Filter	Prefilter	Inspect/Clean	✓			
	Paper Filter	Inspect/Replace			✓	
Fuel Leaks		Inspect/Replace	✓			
Fuel Filter		Inspect/Replace	✓	✓		
Fuel Line		Inspect/Clean	✓			
Spark Plug		Inspect/Clean		✓		
Muffler		Inspect/Clean	✓			
Bolts on muffler		Tighten	✓			
Entire unit		Inspect/Replace	✓			
Muffler Spark Arrester		Inspect/Clean			✓	
Cooling System		Inspect/Clean	✓			
Screws/Nuts/Bolts		Tighten	✓			
Cylinder Exhaust Port		Inspect/Clean				✓

**⚠ WARNING**

**Make sure that the engine has stopped and is cool before performing any service to the blower. Contact with rotating blower fan or hot muffler may result in a personal injury.**

**■ AIR CLEANER**

- Check the air cleaner before use.  
A clogged air filter may increase fuel consumption while cutting down the engine power.
- Never operate the blower without an air filter or with a deformed or broken filter element because unfiltered dusty air will quickly ruin the engine.
- Never clean the paper filter by tapping on it. Doing so may break the element, causing dust to get sucked into the blower and damaging the engine.

**CLEANING AIR FILTER:**

1. Unscrew 2 knob bolts and remove the air cleaner cover. Then remove the prefilter mounted inside the air cleaner cover.

- (1) Knob Bolt      (2) Prefilter  
(3) Paper Filter

2. Wash the prefilter in fresh, non flammable cleaning solution (ex. warm soapy water) and then dry.  
(Clean the air filter once in a week.)
3. Exchange the paper filter element with new one in case it has been contaminated.

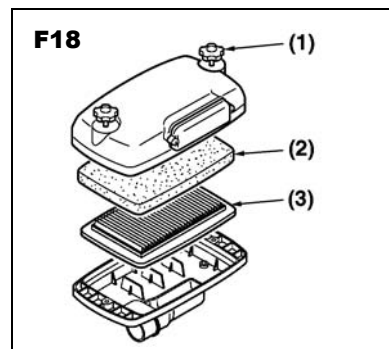

**⚠ WARNING**

- **This prefilter is dry type.**
- **Never wash the prefilter in an oily cleaning solution.**
- **Never include oil in the wash.**
- **Do not clean the paper filter by tapping on it.**

**■ FUEL FILTER**

- A clogged fuel filter may cause poor acceleration of the engine. Check periodically to see if the filter is clogged with dirt. The filter can be taken out of the fueling port using a small wire hook. Disconnect the filter assembly from the fuel pipe and unhook the retainer to disassemble it. Clean the components with gasoline.

- (1) Screen              (2) Element (x 2)  
(3) Holder             (4) Retainer

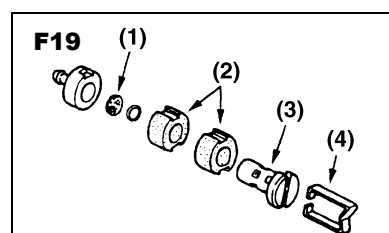

# Maintenance

## ■ SPARK PLUG

- The spark plug may gather carbon deposits on its firing end with reasonable use. Remove and inspect the spark plug every 25 hours and clean the electrodes as necessary with a wire brush. The spark gap should be adjusted to .025 in (0.6 to 0.7mm).
- Plug manufacturers recommend replacing the plug twice a year to avoid unexpected plug failure in a job.  
REPLACEMENT PLUG IS A NGK CMR7H.

### ⚠ IMPORTANT

- **Note that using any spark plugs other than those designated may result in the engine failing to operate properly or in the engine becoming overheated and damaged.**
- **To install the spark plug, first turn the plug with your hands until it is tight, then tighten it a quarter turn more with a socket wrench.**

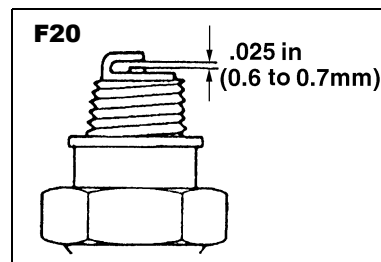

## ■ MUFFLER

### ⚠ WARNING

- **Periodically inspect the muffler for loose fasteners, damage or corrosion. If any sign of exhaust leakage is found, do not use the blower and have it repaired immediately.**
- **Note that failing to do so may result in the engine catching on fire.**

1. Remove the muffler, insert a screwdriver into the vent, and wipe away any carbon buildup. Wipe away any carbon buildup on the muffler exhaust vent and cylinder exhaust port at the same time.
2. Tighten all screws, bolts, and fittings.

## ■ SPARK ARRESTER

- The muffler is equipped with a spark arrester to prevent red hot carbon from flying out of the exhaust outlet. Periodically inspect and clean as necessary with a wire brush.

- |                    |              |
|--------------------|--------------|
| (1) Bolt           | (2) Bolt     |
| (3) Spark Arrester | (4) Diffuser |

### ⚠ WARNING

- **Before starting operation, always make sure to check if the muffler is properly held by three bolts (F21 (2)). (Fastening Torque : 8 to 12 N·m)**
- **Also make sure that the spark arrester and the diffuser are properly attached with four bolts (F21 (1)). (Fastening Torque : 2 to 3 N·m)**
- **Even if one of seven bolts is loose, it may result in engine catching on fire.**

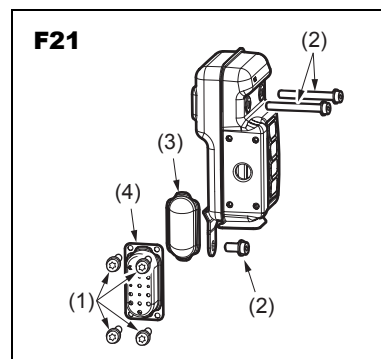

## ■ AIR INLET NET

### ⚠ IMPORTANT

- **Blown air is taken in from the air inlet net. If the air flow drops during operation, stop the engine and inspect the air inlet net for blockage by obstacles.**
- **Note that failure to remove any such obstacles may result in the engine becoming overheated and damaged.**

- (1) Net

### ⚠ WARNING

**Never use the blower without the net on the blower. Before each use, check that the net is attached in place and is free from any damage.**

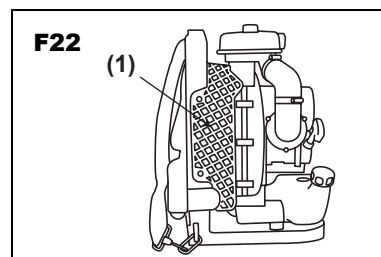

## Maintenance

### ■ IGNITION COIL AIR GAP INSPECTION

- If the gap is not accurate or when installing the coil or rotor, adjust the air gap between the ignition coil and the iron core of the rotor.

#### Air Gap:

0.40mm (0.35 to 0.45mm)

0.016 in (0.014 to 0.017 in)

(1) Rotor

(2) Ignition coil

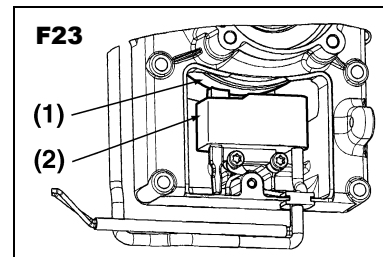

### ■ SHOULDER STRAP

- If the shoulder strap is damaged it may break during use, thus causing the product to fall and resulting in personal injury. Follow the instructions below to replace the shoulder strap with new one.
- Take off the clip from the strap.
- Pass the end of the strap through the hanger.
- Return the clip to the strap.

#### ⓘ IMPORTANT

**Make sure that the thick round bar of the clip is in the strap.**

**If it is attached in the wrong way, it leads to serious personal injury.**

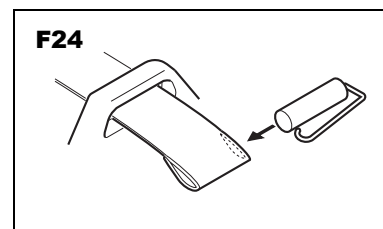

## Storage

### BEFORE STORING THE BLOWER:

1. Drain the fuel tank and push the primer bulb until it becomes empty of fuel.
2. Remove the spark plug and drop a spoonful of 2-cycle oil into the cylinder. Crank the engine several times and install the spark plug.
3. Store unit in a dry, dust free place, out of the reach of children.